



POSSESS THE QUALITY



- CHAINSAWS
- SAW CHAINS
- GUIDE BARS
- BRUSH CUTTER
- EARTH AUGER

KEIL[®] Chainsaw POSSESS THE QUALITY

ABOUT US

We at Keil Tools Private Limited, would like to introduce ourselves as the Professional Importers of Chainsaw Machine, Brush Cutters, Forestry Products like Saw Chains, Guide Bars, Files etc. and other Gardening Machinery & Tools. KEIL specializes in offering Quality Products in the line of Gardening Tools & Forestry Products.

We are having the trade experience of more than 48 years in the line of wood cutting products. We pride ourselves on providing our customers with the excellent quality with the reasonable prices. KEIL provides high quality products that are a better value than the competition.

OUR OTHER FAMILY BRANDS AS FOLLOWS:



INDEX

KEIL Professional Series Chainsaw

KL5820	04
KL5830	05
KL5860	05
KL6050	06
KL7550	06

KEIL Platinum Series Chainsaw

KL5870	07
KL6270	07

KEIL Regular Series Chainsaw

KL5800	08
KL6200	09
KL6230	09

KEIL Prime Series Chainsaw

KL5810	10
KL5815	10
KL6210	10

Sharpon Chainsaw 11

Treecut Chainsaw 11

KEIL Electric Chainsaw

KL1600	12
KL1900	12
KL2000	12
KL2500	13
KL3000	13

KEIL Saw Chains

Keil Platinum Series	14
Keil Blister Series	14

Keil Saw Chain Reels 15

Saw Chains

CRT	16
Crosson	16
Sharpon Gold Series	17
Sharpon (Blister Pack)	17
Sharpon (Metal Box)	17
E & S	18
Treecut	18

KEIL Guide Bars 19

Guide Bars

Treecut	20
Crosson	20
Sharpon	20
Axeon	20

Cylinder Sets (Chainsaw parts) 21

Carburetor (Chainsaw parts) 22

KEIL (Chainsaw parts) 23

KEIL Chain Grinders 24

Keil 4 Stroke Brush Cutter

KL3500	25
KL3550	25

Crosson 4 Stroke Brush Cutter

CR3500	26
CR3550	26

Sharpon 4 Stroke Brush Cutter 27

KEIL Earth Auger 27

KEIL 2 Stroke Brush Cutter

KL5220	28
KL5250	28

Sharpon 2 Stroke Brush Cutter

SH5200	29
SH5250	29

Spare Parts of Chainsaw 30-32

Spare Parts of Brush Cutter 33-34





KEIL[®]
Chainsaw

PROFESSIONAL SERIES CHAINSAWS

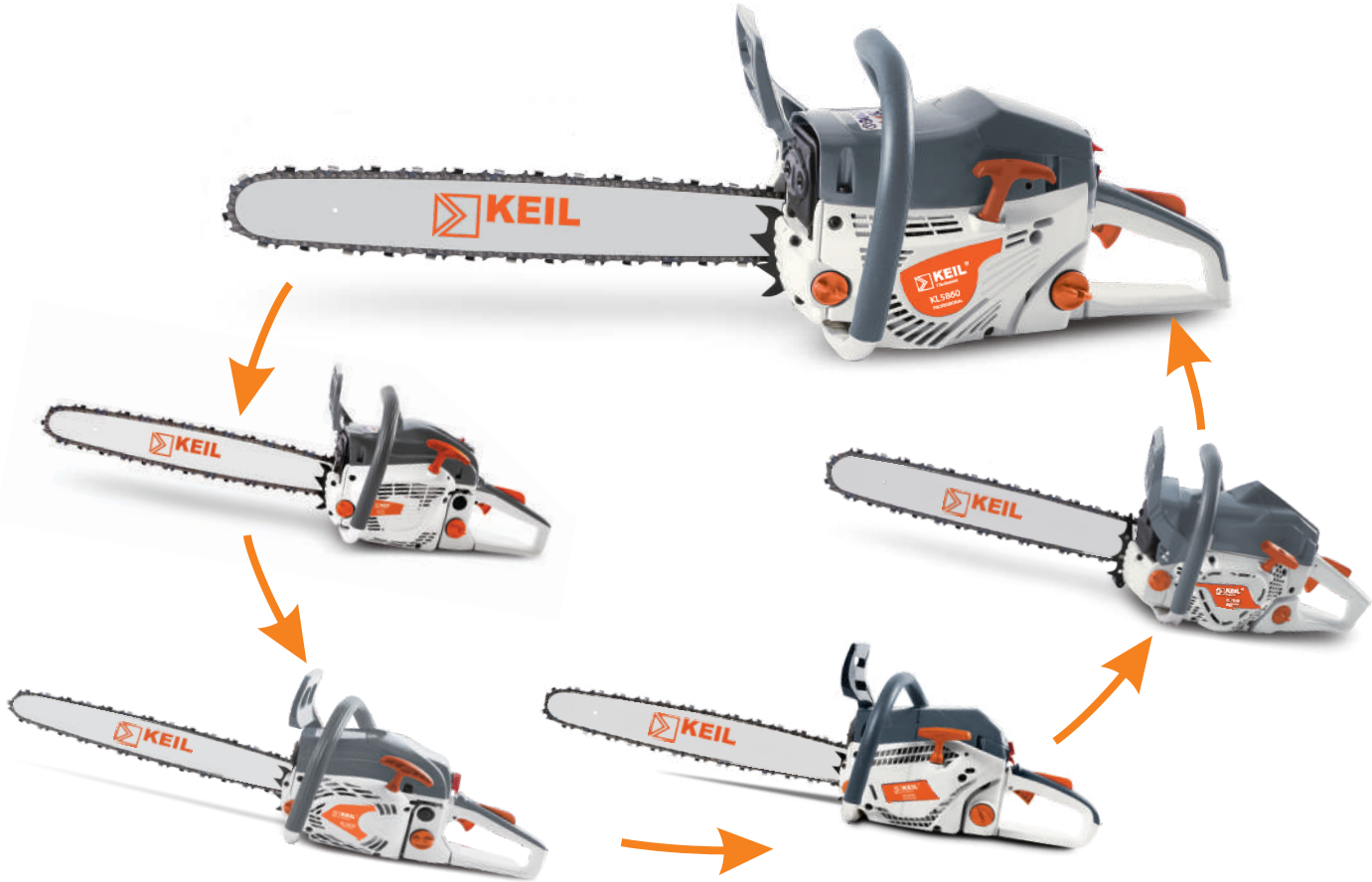

KL 5820 PROFESSIONAL

Displacement	Rated Power	Cutting Capacity	Total Weight
58.0CC	2.2kw/3.0hp	18" / 22"	6.8kg



GASOLINE CHAINSAWS

Designed to satisfy a wide range of users, from the demanding of gardeners requiring a tool for free use, to farmers and professional contractors. Power to weight ratio ensure excellent cutting performance for any use, from limbing and pruning to cutting medium-size trunks.





KEIL[®]
Chainsaw

PROFESSIONAL SERIES CHAINSAWS



KL 5830 PROFESSIONAL

Displacement	Rated Power	Cutting Capacity	Total Weight
58.0CC	2.2kw/3.0hp	18" / 22"	6.8kg



GASOLINE CHAINSAWS

Robust & long lasting chain saw for all round use. Good for harvesting wood in medium size, also highly suitable for agriculture, horticulture & Orchards.



KL 5860 PROFESSIONAL

Displacement	Rated Power	Cutting Capacity	Total Weight
58.0CC	2.2kw/3.0hp	18" / 22"	6.8kg



Excellent power-to-weight ratio ensure outstanding cutting performance for any use, from occasional use to periodical professional use, suit for lopping collecting firewood, felling and cutting up medium to large sized trees. Ideal to handle multiple cutting tasks.



The machine use best in class Walbro Carbtorator & the Graphite Coating Piston for better & long lasting performance



KEIL[®] PROFESSIONAL SERIES CHAINSAWS



KL 6050 PROFESSIONAL

Displacement 60.5CC	Rated Power 2.8kw/3.8hp	Cutting Capacity 24"	Total Weight 7.4kg
-------------------------------	-----------------------------------	--------------------------------	------------------------------



EQUIPPED WITH CRANKCASE INLET TECHNOLOGY



GASOLINE CHAINSAWS

Speed cutting benefit by new technology engine applying, good cooling enable a fast start to the machine in heating weather. Model KL 6050 also feature a low fuel consumption a best choice for semi professional heavy duty usage.

Advantage of Crankcase Inlet Technology

- Less fuel consumption
- Power Stronger
- Temperature lower
- Cutting efficiency higher



KL 7550 PROFESSIONAL

Displacement 75.0CC	Rated Power 3.2kw/4.3hp	Cutting Capacity 18" / 22" / 24" / 28"	Total Weight 9.2kg
-------------------------------	-----------------------------------	--	------------------------------



Heavy duty chainsaw with fuel-efficient engine. Ergonomically improved handles reduce fatigue. Its advanced air filtration system brings the benefits of reduced maintenance and reliable performance. Ideal for working with medium to large strength wood.



KEIL® PLATINUM SERIES CHAINSAWS



KL 5870 PLATINUM

Displacement 58.0CC | **Rated Power** 2.6kw /3.5hp | **Cutting Capacity** 22" | **Total Weight** 7.0kg



GASOLINE CHAINSAWS

INTRODUCING OUR NEW RANGE OF KEIL "PLATINUM SERIES" CHAINSAWS.

Hold this chainsaw and you will feel boost of power right away This chainsaw comes with following features –

- Keil Blister chain
- Keil Titanium Alloy Guide Bar
- Aluminium Made Starter Assembly
- Soft Touch Grip on Handle
- Cylinder and Carburetor Top Quality



KL 6270 PLATINUM

Displacement 62CC | **Rated Power** 2.9kw /3.9hp | **Cutting Capacity** 22" | **Total Weight** 7.0kg



GASOLINE CHAINSAWS

INTRODUCING OUR NEW RANGE OF KEIL "PLATINUM SERIES" CHAINSAWS.

Hold this chainsaw and you will feel boost of power right away This chainsaw comes with following features –

- Keil Blister chain
- Keil Titanium Alloy Guide Bar
- Aluminium Made Starter Assembly
- Soft Touch Grip on Handle
- Cylinder and Carburetor Top Quality





KEIL[®]
Chainsaw

REGULAR SERIES CHAINSAWS

KL 5800



KL 6230



KL 6200



KL 5800

Displacement	Rated Power	Cutting Capacity	Total Weight
58.0cc	2.5kw/3.4hp	18"/22"	7.3kg



GASOLINE CHAINSAWS

The hottest selling model of KEIL. This chainsaw provides the user good quality with reasonable prices.



Hot Selling



- Aluminum Starter Assembly
- Paper Air Filter
- Triple Hole Silencer



- Premium Quality 58 cc Cylinder Set
- Good Quality Carburetor
- Equipped with Fuel Primer for Easy Starting



8



KEIL[®]
Chainsaw

REGULAR SERIES CHAINSAWS



KL 6200

Displacement 62CC	Rated Power 2.9kw /3.9hp	Cutting Capacity 22"	Total Weight 6.8kg
-----------------------------	------------------------------------	--------------------------------	------------------------------



Powerful Chainsaw with Aluminium Made Starter assembly , providing long lasting life.

- Aluminium Starter assembly
- Paper Air Filter
- Cylinder & Carburetor Premium Quality
- Equipped with Keil chain (German Steel) & Keil bar



KL 6230

Displacement 62CC	Rated Power 2.9kw /3.9hp	Cutting Capacity 22"	Total Weight 6.8kg
-----------------------------	------------------------------------	--------------------------------	------------------------------



Powerful Chainsaw with good outlook , providing long lasting life.

- Cylinder & Carburetor Premium Quality
- Equipped with Keil chain (German Steel) & Keil bar
- Powerful 62cc Engine



KEIL® PRIME SERIES CHAINSAWS

Chainsaw



KL 5810 PRIME

Displacement 58CC	Rated Power 2.6kw /3.54hp	Cutting Capacity 22"	Total Weight 6.8kg
-----------------------------	-------------------------------------	--------------------------------	------------------------------



Keil Chain 22"
(German Steel)

The newly designed outlook giving you a different feeling of modernity. This chainsaw offers you good quality and that too with reasonable pricing.

Plastic quality and the spare parts used inside the machines are of one of the best quality.



KL 5815 PRIME

Displacement 58CC	Rated Power 2.6kw /3.54hp	Cutting Capacity 22"	Total Weight 6.8kg
-----------------------------	-------------------------------------	--------------------------------	------------------------------



Keil Chain 22"
(German Steel)

The newly designed outlook giving you a different feeling of modernity. This chainsaw offers you good quality and that too with reasonable pricing.

Plastic quality and the spare parts used inside the machines are of one of the best quality.



KL 6210 PRIME

Displacement 62CC	Rated Power 2.9kw /3.9hp	Cutting Capacity 22"	Total Weight 6.8kg
-----------------------------	------------------------------------	--------------------------------	------------------------------



Keil Chain 22"
(German Steel)

Powerful long lasting chainsaw offers you the power just at the moment you need it delivered. Soft touch rubber handles , helps you get to take over the control of the machine more accurately . This chainsaw delivers 62cc power on the go.



sharp-on® CHAIN SAW SERIES

sharp-on®

SH 6200 SHARP ON

Displacement	Rated Power	Cutting Capacity	Total Weight
62CC	2.5 kw / 3.4 hp	22"	6.8kg



The only chainsaw coming under our Sharpon brand. Providing 62cc power with much reasonable pricing. Comes with Aluminium made starting cover and soft touch rubber grip to make it your rough-tough tool.



TC TREE CUT CHAIN SAW SERIES

TC TREE CUT

TC 5800 TREECUT

Displacement	Rated Power	Cutting Capacity	Total Weight
58CC	2.5kw /3.4hp	22"	6.8kg



This is the entry level model of chainsaw on offer . Equipped with Triple hole silencer and good quality saw chain with a totally different and new outlook. You can still count on it on terms of quality it is giving under this pricing .



KEIL® ELECTRIC CHAINSAWS

Chainsaw



KL 1600

Power 1600 W	Motor Copper	Voltage 220 V	Saw Chain Speed 480 M/Min.	Bar Length 16"	Total Weight 4.2kg
------------------------	------------------------	-------------------------	--------------------------------------	--------------------------	------------------------------



ELECTRIC CHAINSAW

Entry level model of the KEIL Electric Chainsaw. Ideal for cutting small wooden logs. Basically for Home or Semi-Professional usage.



KL 1900

Power 1900 W	Motor Copper	Voltage 220 V	Saw Chain Speed 480 M/Min.	Bar Length 16"	Total Weight 5.0kg
------------------------	------------------------	-------------------------	--------------------------------------	--------------------------	------------------------------

Automatic Oiling System



Aluminium Gear Box

This electric chainsaw comes with 1900 watts motor power with copper armature and field. It is equipped with Automatic Oiling system and Aluminium Gear Box.



KL 2000

Power 2000 W	Motor Copper	Voltage 220 V	Saw Chain Speed 480 M/Min.	Bar Length 16" + 18"	Total Weight 5.2kg
------------------------	------------------------	-------------------------	--------------------------------------	--------------------------------	------------------------------

Automatic Oiling System



Soft Touch Grip

Aluminium Gear Box

- The only electric chainsaw in Keil coming with two complementary sizes – 16" + 18"
- With this machine, you get 2 bars and 2 chains of 16" and 18" each
- Automatic Oiling System
- Aluminium Gear Box
- Bigger 18" bar to meet the needs of cutting larger wooden log



KEIL® ELECTRIC CHAINSAWS

Chainsaw



KL 2500

Power 2500 w	Motor Copper	Voltage 220 v	Saw Chain Speed 800 M/Min.	Bar Length 22"
------------------------	------------------------	-------------------------	--------------------------------------	--------------------------

ELECTRIC CHAINSAW

This Keil electric chainsaw gives you 2500 watts power with the guide bar size of 22".

Hence, the bar and chain of this machine is interchangeable with Petrol chainsaw bar and chain of 22".

Soft touch grip on the front handle and back handle, gives you better grip over the machine

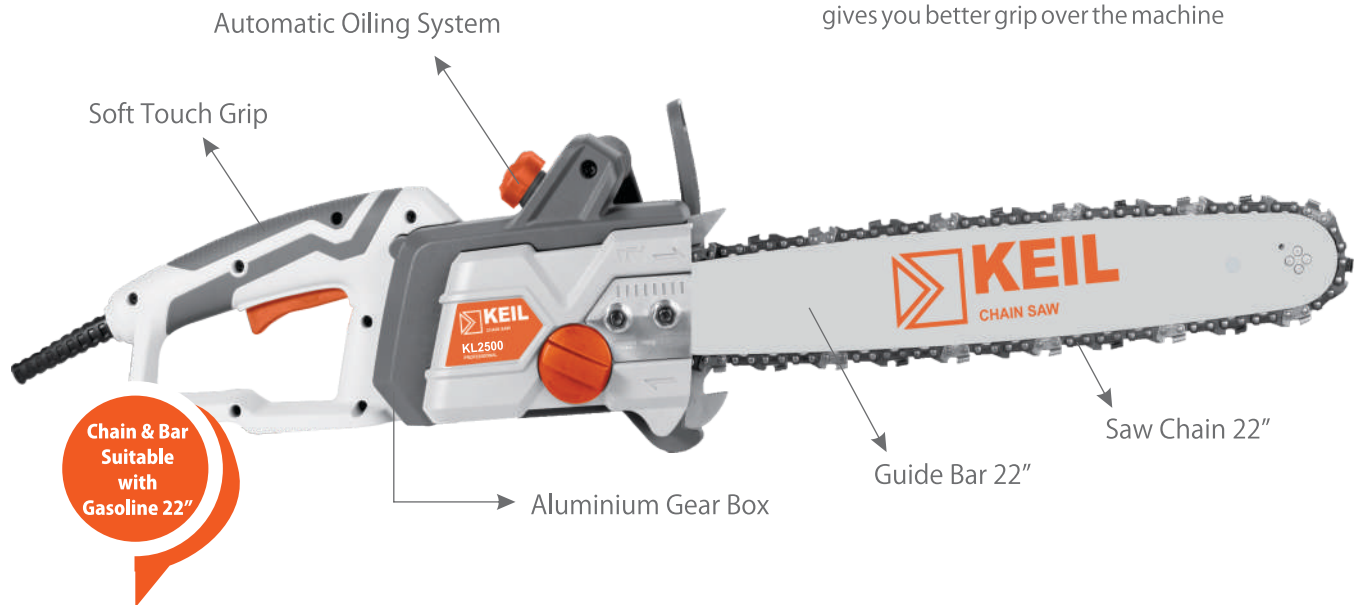

KL 3000

Power 3000 w	Motor Copper	Voltage 220 v	Saw Chain Speed 800 M/Min.	Bar Length 24" / 28" / 36"	Total Weight 9.3kg
------------------------	------------------------	-------------------------	--------------------------------------	--------------------------------------	------------------------------

The most powerful electric chainsaw machine equipped with copper armature delivering 3000 watts actual power to meet the cutting needs of professional users.

The first single phase electric chainsaw providing 24"/28"/36" guide plate to satisfy the professional needs of the users effectively and efficiently.

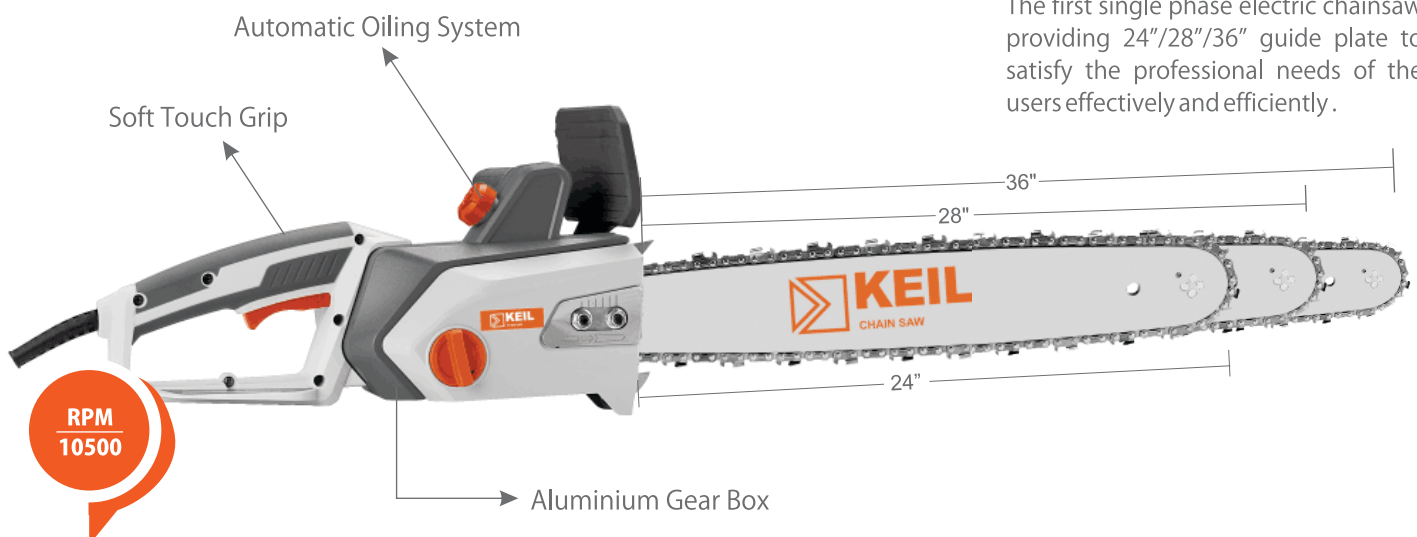



KEIL PLATINUM SERIES



KEIL "PLATINUM SERIES", firstly introduced in India by KEIL, is a fully professional saw chain having an additional platinum layering on the saw chains to give the users more cutting time without sharpening the chains repeatedly. Hence, the sharpness stays for a longer duration due to the platinum coating and smoothness on the saw chain.

Available Sizes –

- 16" (For Electric chainsaw)
- 18" (For Gasoline Chainsaw)
- 22" (For Gasoline Chainsaw)
- 24" (For Gasoline chainsaw & Ms382)
- .404" Saw Chain Reels

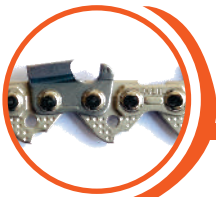

KEIL CHAINS BLISTER SERIES



Keil Blister series saw chain are made with 100% German Steel with precision of hardening and tempering in order to provide with maximum cutting time and life.

Available Sizes –

- 16" (For Electric Chainsaw)
- 18" (For Gasoline Chainsaw)
- 22" (For Gasoline Chainsaw)
- 24" (For Gasoline Chainsaw)
- 21" (For Shapura Electric Chainsaw 1PH 21")



KEIL[®] SAW CHAIN REELS

Chainsaw



3/8" FULL CHISEL PROFESSIONAL



STYLE NO.	PITCH	GAUGE	FILE	GRINDING ANGLE	DEPTH GAUGE
8B 100R	3/8"	.050"	7/32"	30°	.028"
8C 100R	3/8"	.058"	7/32"	30°	.028"
8D 100R	3/8"	.063"	7/32"	30°	.028"

- Full chisel cutters engineered for fast, smooth cutting at high speeds.
- Advanced heat treatment and hard chrome processes allow for improved cutter performance.



.404" FULL CHISEL PROFESSIONAL



STYLE NO.	PITCH	GAUGE	FILE	GRINDING ANGLE	DEPTH GAUGE
9D 100R	.404"	.063"	7/32"	30°	.035"

- Full chisel cutters engineered for fast, smooth cutting at high speeds.
- Recommended for saws over 70cc
- Used for Indian manufactured chain saw machinee.

KEIL performs a precisely controlled tempering process to its best cutters which results in a blue surface color and improved resistance to corrosion in the presence of protective oil.

Chrome-Plated Cutters

- Chrome Offers increased surface harness and wear resistance.
- Cutters stay sharp for longer durations through use, resulting in more time cutting and less time filing or grinding the chain.



SAW CHAINS

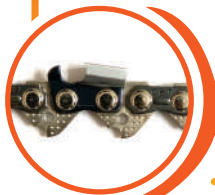
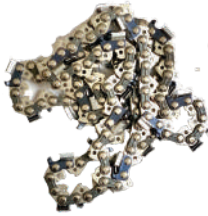

Available Sizes –

- 18" (For Gasoline Chainsaw)
- 22" (For Gasoline Chainsaw)



Available Sizes –

- 18" (For Gasoline Chainsaw)
- 22" (For Gasoline Chainsaw)

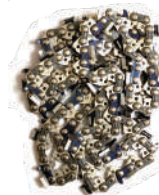

SAW CHAINS

sharp-on®

sharp-on® GOLD SERIES

Available Sizes –

- 18" (For Gasoline Chainsaw)
- 22" (For Gasoline Chainsaw)



sharp-on®

sharp-on® (Blister Pack)

Available Sizes –

- 18" (For Gasoline Chainsaw)
- 22" (For Gasoline Chainsaw)



sharp-on®

sharp-on® (Metal Box)

Available Sizes –

- 18" (For Gasoline Chainsaw)
- 22" (For Gasoline Chainsaw)

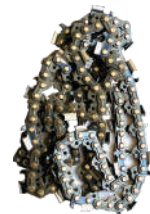

SAW CHAINS

E & S

E & S CHAINS

Available Sizes –

- 18" (For Gasoline Chainsaw)
- 22" (For Gasoline Chainsaw)



TREE CUT

TREE CUT (Metal Box)

Available Sizes –

- 18" (For Gasoline Chainsaw)
- 22" (For Gasoline Chainsaw)



GUIDE BARS



KEIL RSN & LAMINATED BARS



KEIL GUIDE BAR

Our guide bars are designed to provide a guide and support rail for the moving saw chain. Our guide bar types include: Carving Bars, Mini Laminated Sprocket Nose, Laminated Sprocket Nose, Replaceable Sprocket Nose, and Hard Nose bars.

READING THE KEIL PART NUMBER

Guide Bar Numbering System

Example Part Number:

L 3 58 15 56 - 4009 KL

Bar Type	Chain Pitch	Chain Gauge	Bar Length	Drivelink Count	Bar Mount	Brand
L - Laminated	1 - 3/8" LP	43 - .043"	6" - 36"	66-66 drivelinks	Applications List	KL - KEIL
R - Replaceable Sprocket Nose	2 - .325"	50 - .050"				
H - Hard Nose	3 - 3/8"	58 - .058"				
CB - Carving Bar	4 - .404"	63 - .063"				
		80 - .080"				



KEIL Replaceable Sprocket Nose & Laminated Bars

KEIL PART NO.	BAR TYPE	BAR LENGTH	DRIVE LINKS	PITCH	GAUGE	OREGON PART NO.
R4632883-4176KL	REPL. SPRC. NOSE	28" (70cm)	84	.404"	.063"	2B3RNF176
R4632580-5031KL	REPL. SPRC. NOSE	25" (63cm)	82	.404"	.063"	25RNFE031
R4632168-5031KL	REPL. SPRC. NOSE	21" (53cm)	68	.404"	.063"	213RNF031
R3502172-4176KL	REPL. SPRC. NOSE	21" (53cm)	73	3/8"	.0503"	210RN00176
R3632584-4025KL	REPL. SPRC. NOSE	25" (63cm)	84	3/8"	.063"	24RN00025
R3631866-4025KL	REPL. SPRC. NOSE	18" (45cm)	66	3/8"	.063"	1BRN00025
R3581868-4009KL	REPL. SPRC. NOSE	18" (45cm)	68	3/8"	.058"	188RN00009
R2582286RSN	REPL. SPRC. NOSE	22" (55cm)	86	.325"	.058"	
R2581872RSN	REPL. SPRC. NOSE	18" (45cm)	72	.325"	.058"	
L2582286LAM	LAMINATED	22" (55cm)	86	.325"	.058"	
L2581872LAM	LAMINATED	18" (45cm)	72	.325"	.058"	



- Solid bars are laser cut for precision fit to exact tolerances.
- Guide bar rails are hardened for extra wear.



KEIL TITANIUM ALLOY GUIDE BAR



KEIL Titanium Alloy Guide Bars are made with premium quality steel providing you longer life duration

Available Sizes –

- 18" (For Gasoline Chainsaw)
- 22" (For Gasoline Chainsaw)

KEIL Sprocket Nose

KEIL PART NO.	DESCRIPTION	PITCH	GAUGE	OREGON PART NO.
SPNS404	Replaceable Sprocket Nose	.404"	.050", .058", .063"	30855
SPNS38	Replaceable Sprocket Nose	3/8"	.050", .058", .063"	30853
SPNS325	Replaceable Sprocket Nose	.325"	.050", .058", .063"



GUIDE BARS



Available Sizes –

- 16" (For Electric Chainsaw)
- 18" (For Gasoline Chainsaw)
- 22" (For Gasoline Chainsaw)



Available Sizes –

- 16" (For Electric Chainsaw)
- 18" (For Gasoline Chainsaw)
- 22" (For Gasoline Chainsaw)

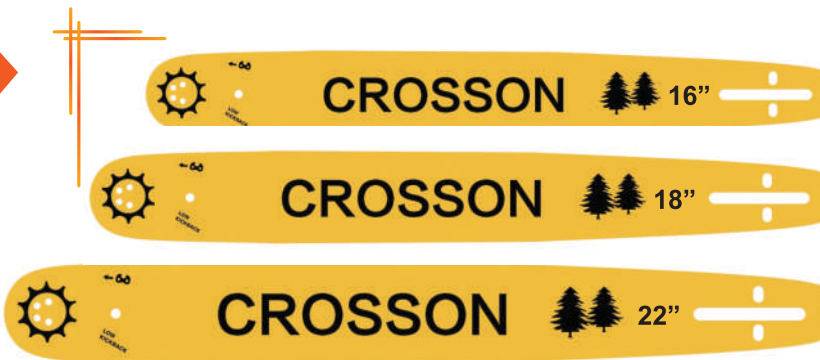

Available Sizes –

- 16" (For Electric Chainsaw)
- 18" (For Gasoline Chainsaw)
- 22" (For Gasoline Chainsaw)



Available Sizes –

- 16" (For Electric Chainsaw)
- 18" (For Gasoline Chainsaw)
- 22" (For Gasoline Chainsaw)



CYLINDER SETS (Chain saw parts)



KEIL[®]
Chainsaw



GRT[®]



sharp-on[®]



CROSSON[®]

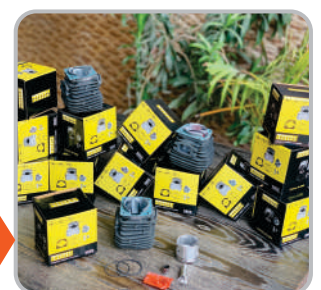

TREE CUT



CARBURETORS (Chain saw parts)



KEIL[®]
Chainsaw PRO



KEIL[®]
Chainsaw ECO



sharp-on[®]

sharp-on[®]



CROSSON

CROSSON[®]



TREE CUT

TREE CUT



KEIL® CHAIN SAW PARTS



KEIL® FILES

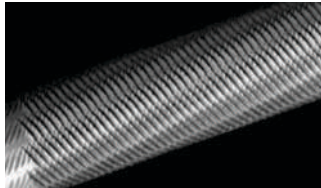

KEIL PART NO.	DESCRIPTION	SIZE
532FKL	Round Files	5132" (4.0 MM)
316FKL	Round Files	3/16" (4.8 MM)
732FKL	Round Files	7/32" (5.5 MM)

- Precision spiral cut design provides clean, fast sharpening without scoring the cutter surfaces.
- Hardened carbon steel construction for longer tool life.



sharp-on® FILES

Available Sizes –

- 4.0mm / 5/32" (For Electric Chainsaw 16")
- 4.8mm / 3/16" (For Gasoline Chainsaw 18"/22")

3 pcs
Blister
Pack



KEIL CHAIN BREAKER



KEIL PART NO.	DESCRIPTION
BK001KL	Saw Chain Breaker - Box Packaging
SBK001KL	Saw Chain Breaker and Rivet Spinner Combo Pack - Box Packaging

- Hardened steel construction for longer tool life
- Punch sizes for all saw chain sizes 3/8" LP, .325", 3/8" and .404"
- Mounts to benches for easy rivet breaking



KEIL RIVET SPINNER



KEIL PART NO.	DESCRIPTION
SP001KL	Saw Chain Rivet Spinner - Box Packaging
SBK001KL	Saw Chain Breaker and Rivet Spinner Combo Pack - Box Packaging

- Hardened steel construction for longer tool life
- Produces strong and secure rivets for all saw chain sizes 3/8" LP, .325", 3/8" and .404"
- Mounts to benches for easy rivet breaking

KEIL® CHAIN GRINDERS

Chainsaw



KEIL CHAIN GRINDING MACHINE (HEAVY)



SPECIFICATIONS	FEATURES
Single Phase, Direct Drive, One-way	One-Way Motor
120v, 60hz, 4.3a, 300w, 3400 Rpm, 0.4 Hp Motor	Set Top Plate Angle
Manual Chain Clamping Vise	Built - In Light
Grinds 1/4", 3/8" Low Pro, .325" 3/8" & .404" Pitch Saw Chain	Set Down Angle
Weight: 20 Lbs, Height: 19.1/2"	Self Centering Chain Vise



KEIL MINI GRINDER



The compact alternative to full size bench grinders. A quality tool that delivers precision result in a very small space.

Comes with one grinding wheel, a wheel - dressing brick and a template for pitch, depth-gauge setting and wheel contour. "Sharpens many 1/4", .325" and mini 3/8 - pitch chain" Sharpens most chain upto .404" - pitch with optional wheels available seperately Runs on standard 115 volt power.

KEIL PART NO.	DESCRIPTION / PACKAGING
EX002KL	Bench mounted Mini Grinder

TECHNICAL SPECIFICATIONS	
Model	220v, 50 Hz
Power	85w
Wheel Dimensions	105x22mm
Max Grinding Rotation	4500 rpm



TREE CUT CHAIN GRINDER



TECHNICAL SPECIFICATION	
Model	TC 400
Voltage / Frequency	230 V-50HZ
Power	250W
No - Load Speed	8400 R/MIN
Grinding Wheel	100 x 10 x 3.2 mm



KEIL® 4 STROKE BRUSH CUTTER

Chainsaw



KL 3500 4 STROKE

Side Pack
(4 Stroke)

TECHNICAL SPECIFICATION	
Idle Speed	3000 - 3400 rpm
Engine	GX 35
Fuel Tank Capacity	0.6 L
G.W / N.W	10 Kg / 9 Kg
Displacement	35.8 cc



KL 3550 4 STROKE

TECHNICAL SPECIFICATION	
Idle Speed	3000 - 3400 rpm
Engine	GX 35
Fuel Tank Capacity	0.6 L
G.W / N.W	10 Kg / 9 Kg
Displacement	35.8 cc

Back Pack
(4 Stroke)





CR 3500 4 STROKE

High Quality Gear Box

Strong Handle Holder

Premium Quality Handle



Side Pack
(4 Stroke)

TECHNICAL SPECIFICATION

Idle Speed	3000 - 3400 rpm
Engine	GX 35
Fuel Tank Capacity	0.6 L
G.W / N.W	10 Kg / 9 Kg
Displacement	35.8 cc



CR 3550 4 STROKE

Equipped with High Quality Durable Handle set

Flexible Shaft

TECHNICAL SPECIFICATION

Idle Speed	3000 - 3400 rpm
Engine	GX 35
Fuel Tank Capacity	0.6 L
G.W / N.W	10 Kg / 9 Kg
Displacement	35.8 cc

High Quality Gear Box

Back Pack
(4 Stroke)

Strong Frame



sharp-on® 4 STROKE BRUSH CUTTER

sharp-on®

SH 3500 4 STROKE

High Quality Gear Box

Strong Handle Holder

Premium Quality Handle

Side Pack
(4 Stroke)

TECHNICAL SPECIFICATION	
Idle Speed	3000 - 3400 rpm
Engine	GX 35
Fuel Tank Capacity	0.6 L
G.W / N.W	10 Kg / 9 Kg
Displacement	35.8 cc



KEIL®
Chainsaw

EARTH AUGER

KEIL®
Chainsaw

KLEA 52 EARTH AUGER



2 Stroke
Earth
Auger

TECHNICAL SPECIFICATION	
Displacement	52 cc
Engine	2 Stroke
Fuel Tank Capacity	0.85 L
Bit Size Options	2", 3", 4", 6", 8" 10", 12"
Dry Weight	8.5 kg



KEIL® 2 STROKE BRUSH CUTTER

Chainsaw



KL 5220 2 STROKE

TECHNICAL SPECIFICATION	
Displacement	52 cc
Rated Power	1.5 kw / 2.04 hp
Engine	2 Stroke
Fuel Tank Capacity	0.85 L



KL 5250 2 STROKE

TECHNICAL SPECIFICATION	
Displacement	52 cc
Rated Power	1.5 kw / 2.04 hp
Engine	2 Stroke
Fuel Tank Capacity	0.85 L

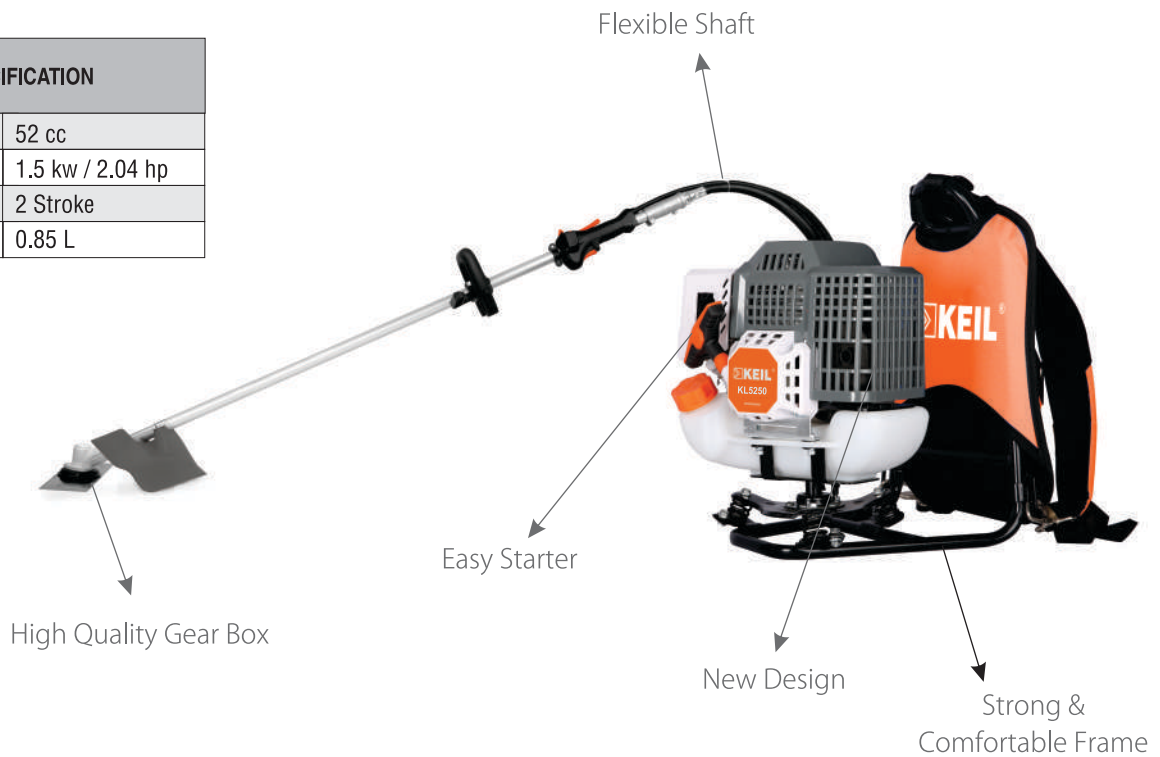

sharp-on® 2 STROKE BRUSH CUTTER

sharp-on®

SH 5200 2 STROKE

TECHNICAL SPECIFICATION

Displacement	52 cc
Rated Power	1.5 kw / 2.04 hp
Engine	2 Stroke
Fuel Tank Capacity	0.85 L



Side Pack
(2 Stroke)

sharp-on®

SH 5250 2 STROKE

TECHNICAL SPECIFICATION

Displacement	52 cc
Rated Power	1.5 kw / 2.04 hp
Engine	2 Stroke
Fuel Tank Capacity	0.85 L



Back Pack
(2 Stroke)

SPARE PARTS (CHAIN SAW-5800/6200)



Crankcase
P.No. 5800-01



Cylinder Kit(45.2mm)
P.No. 5800-02



Piston Set (45mm)
P.No. 5800-03



Crankshaft
P.No. 5800-04



Crankshaft Rod Kit
P.No. 5800-05

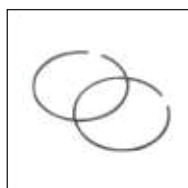

Piston Ring (45.2mm)
P.No. 5800-06



Woodruff Key
P.No. 5800-07



Muffler assy
P.No. 5800-08



Needle Cage(Piston)
P.No. 5800-09



Needle Cage(Crankshaft)
P.No. 5800-10



Oil Seal (2pcs./set)
P.No. 5800-11



Plate
P.No. 5800-12



Right Oil Seal
P.No. 5800-13



Clutch Support
P.No. 5800-14

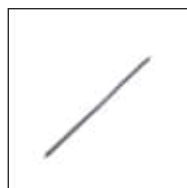

Clutch Spring
P.No. 5800-15



Oil Pump Cover
P.No. 5800-16



Oil Pump Worm
P.No. 5800-17



Rim Sprocket
P.No. 5800-18



Super Sprocket
P.No. 5800-19



Contact Spring
P.No. 5800-20



FlyWheel (Metal Pawl)
P.No. 5800-21



FlyWheel (Plastic Pawl)
P.No. 5800-22

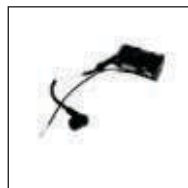

Ignition Coil
P.No. 5800-23



Starter
P.No. 5800-24



Switch Shaft
P.No. 5800-25



Easy Starter
P.No. 5800-26



Starter Pulley
P.No. 5800-27



Starter Rewing Spring
P.No. 5800-28



Pawl Set (Plastic)
P.No. 5800-29



Pawl Set (Metal)
P.No. 5800-30

SPARE PARTS (CHAIN SAW-5800/6200)



Starter Grip
P.No. 5800-31



Starter Rope
P.No. 5800-32



Fuel Hose
P.No. 5800-33



Handle Molding
P.No. 5800-34

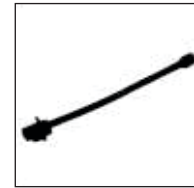

Oil Hose
P.No. 5800-35

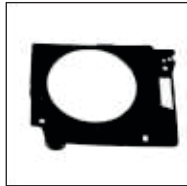

Segment
P.No. 5800-36



Tank Housing
P.No. 5800-37

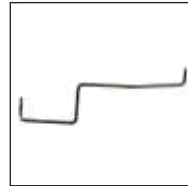

Throttle Rod
P.No. 5800-38



Throttle Trigger
P.No. 5800-39

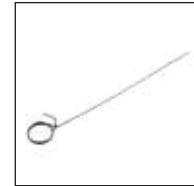

Torsion Spring
P.No. 5800-40



Trigger Interlock
P.No. 5800-41



45cc Shroud or Shield
Shield (Cylinder)

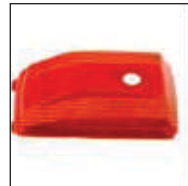

45cc Air Filter Cover
P.No. 5800-43



Air Filter
P.No. 5800-44



Oil Filter(Pickup Body)
P.No. 5800-45



Fuel Filter(Pickup Body)
P.No. 5800-46

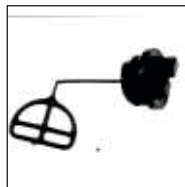

Fuel Tank Cap
P.No. 5800-47



Handlebar
P.No. 5800-48



Oil Pump Out Hose
P.No. 5800-49



Oil Tank Cap
P.No. 5800-50



52cc Air Filter Cover
P.No. 5800-51



55ccv Shroud or Shield
(Cylinder) P.No. 5800-52



Brether Assy
P.No. 5800-53

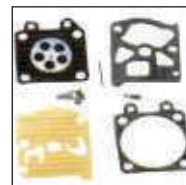

Carburetor Repair Kit
P.No. 5800-54



Choke Lever
P.No. 5800-55



Flange
P.No. 5800-56



Manifold
P.No. 5800-57



Twist Lock
P.No. 5800-58



Brake Band
P.No. 5800-59



Brake Spring
P.No. 5800-60

SPARE PARTS (CHAIN SAW-5800/6200)



Chain Catcher (Plastic)
P.No. 5800-61



Chain Catcher (Metal)
P.No. 5800-62



Collar Screw
P.No. 5800-63

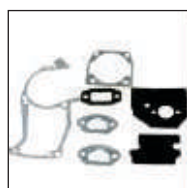

Gasket Set
P.No. 5800-64



Glode Bar Bolt
P.No. 5800-65



Inner Side Plate
P.No. 5800-66



Outter Side Plate
P.No. 5800-67



Oil Pump
P.No. 5800-68



Clutch
P.No. 5800-69



Rim
P.No. 5800-70



Spark Plug
P.No. 5800-71



Tank Housing
P.No. 5800-72



Carburetor
P.No. 5800-73



Needle Cage(Clutch)
P.No. 5800-74



Easy Starter Pulley
P.No. 5800-75



Wrench
P.No. 5800-76



Hose Clip
P.No. 5800-77



Manifold Bracket
P.No. 5800-78



Air Filter Adaptor
P.No. 5800-79



Small Annular Buffer
P.No. 5800-80



Chain Sprocket
Cover Assy
P.No. 5800-81



File
P.No. 5800-82



Guide Bar
P.No. 5800-83



Saw Chain
P.No. 5800-84



Saw Chain Link
P.No. 5800-85

SPARE PARTS (BRUSH CUTTER)



Crankcase
CG430/520-01



Piston Set(44mm)
CG430/520-02

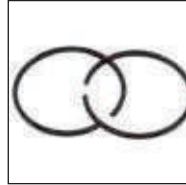

43cc Piston Ring (40mm)
CG430/520-03

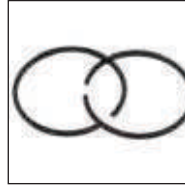

Piston Ring (44mm)
CG430/520-04



Big Oil Seal
CG430/520-05



Small Oil Seal
CG430/520-06



Needle Cage (Piston)
CG430/520-07



Needle Cage (Crankshaft)
CG430/520-08



Muffler
CG430/520-09



Ignition Coil
CG430/520-10



FlyWheel
CG430/520-11



Spark Plug
CG430/520-12



Starter
CG430/520-13



Steel Starter
CG430/520-14



Starter Rope Rotor
CG430/520-15



Steel Wire Starter Rope Rotor
CG430/520-16



Easy Starter Rope Rotor
CG430/520-17



Starter Rewind Spring
CG430/520-18



Easy Starter Rewind Spring
CG430/520-19



Starter Pulley
CG430/520-20



Steel Wire Starter Pulley
CG430/520-21



Easy Starter Pulley
CG430/520-22



Starter Grip
CG430/520-23



Starter Rope
CG430/520-24



Tank Housing
CG430/520-25



Fuel Tank Cap
CG430/520-26



Fuel Hose
CG430/520-27



Fuel Filter (Pickup Body)
CG430/520-28



Fuel Support
CG430/520-29



Air Filter Assy
CG430/520-30

SPARE PARTS (BRUSH CUTTER)



Muffler Cover
CG430/520-31



Carburetor
CG430/520-32

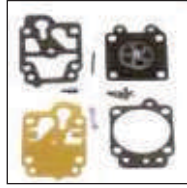

Carburetor Repair Kit
CG430/520-33



Manifold
CG430/520-34



Clutch
CG430/520-35



Clutch Spring
CG430/520-36



Clutch Screw
CG430/520-37



Clutch Shroud
CG430/520-38



Gasket Set
CG430/520-39



Clutch Housing Assy
CG430/520-40



Clutch Drum
CG430/520-41



Pipe with Shaft
CG430/520-42



Drive Shaft
CG430/520-43



Rubber Bearing
CG430/520-44



Handle Holder
CG430/520-45



Handle Set
CG430/520-46



Right Handle
CG430/520-47

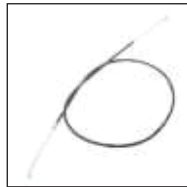

Throttle Cable
CG430/520-48



Grass Shield
CG430/520-49



Gear Head
CG430/520-50



Gear Head Nut
CG430/520-51



Nylon Blade
CG430/520-52



Wrench
CG430/520-53



Carry Belt
CG430/520-54



Metal Blade 3T
CG430/520-55



43cc Cylinder Kit (40mm)
CG430/520-56



Easy Starter
CG430/520-57



43cc Crankshaft
CG430/520-58

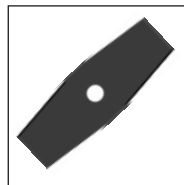

Metal Blade 2T
CG430/520-59

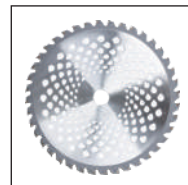

Alloy Blade
CG430/520-+60



KEIL[®]
Chainsaw

POSSESS THE QUALITY



OUR OTHER FAMILY BRANDS AS FOLLOWS:

GRT[®]

CROSSON

sharp-on[®]



TREE CUT



AXE-ON



POSSESS THE QUALITY

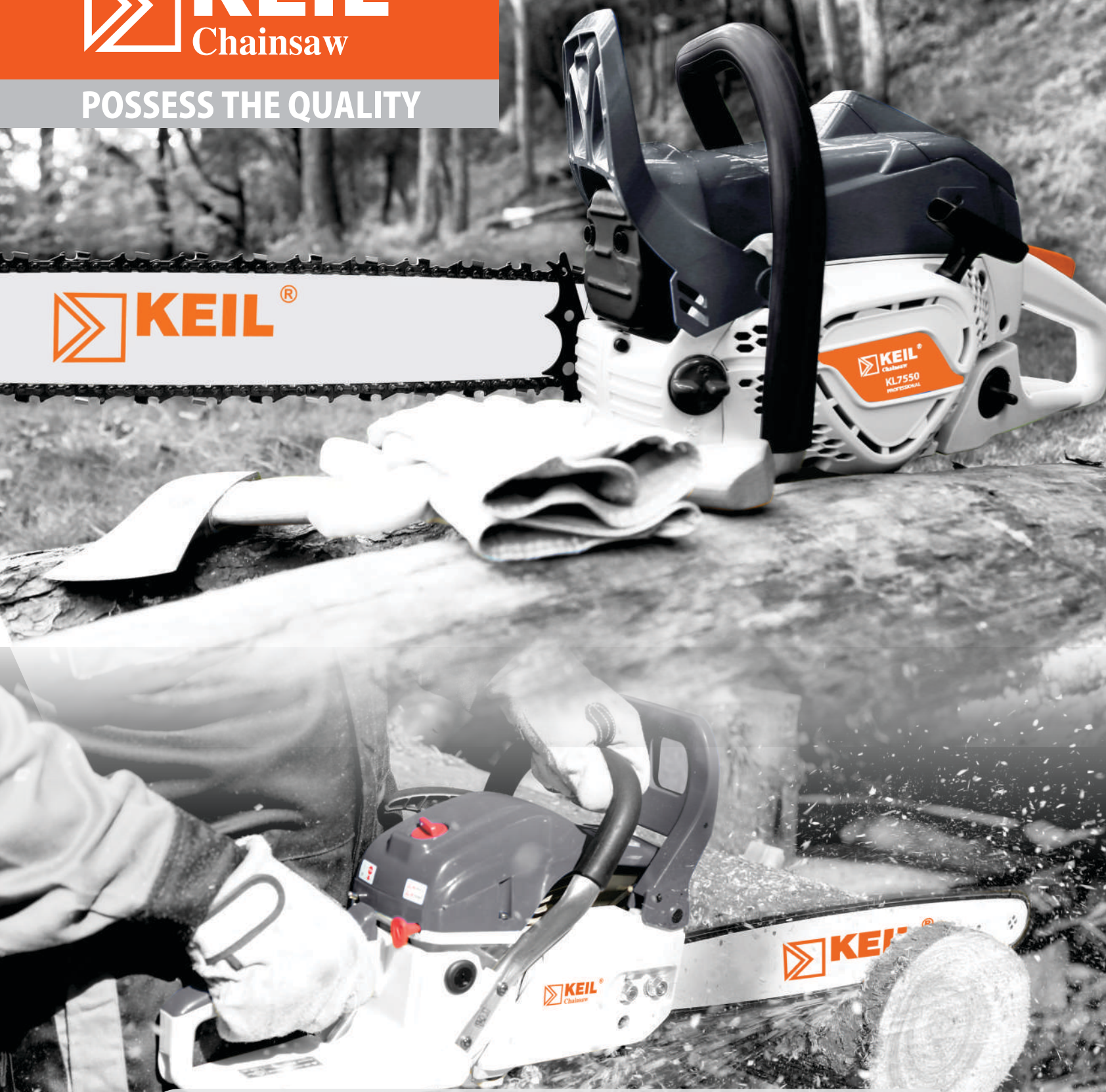

KEIL TOOLS PRIVATE LIMITED

3853, Shah Ganj, Behind Hanuman Mandir,
G.B. Road, DELHI - 110006 India

M : +91-9811158461, 9811018461 | Tel(O) : +91-11-40348461

E : keilchain@gmail.com | Web : www.keilchainsaw.com

- CHAINSAWS
- SAW CHAINS
- GUIDE BARS
- BRUSH CUTTER
- EARTH AUGER